



CNC SWISS TYPE AUTOMATIC LATHE 

# SR-32JIII





**The SR-32JII series offers a choice of layouts to give the User even more capability to help meet their manufacturing requirements.**

Star Micronics has again listened to Customers' requirements and produced this flexible machine to help them respond to ever-changing needs for part machining in the global arena. The SR-32JII series enables medium complex to complex components to be produced whilst still offering unrivalled high rigidity and accuracy.

There are two types of the latest model "SR-32JIII" - type A with a back working 6 spindle unit and type B with back working 8 spindle unit

# SR-32JIII

## type A

### CNC SWISS TYPE AUTOMATIC LATHE

- Machine composition :
- Main spindle
  - Sub spindle
  - Gang type Tool post
    - Cartridge-type 5-spindle cross drilling unit
    - Cartridge-type 6-spindle cross drilling unit
    - 6-spindle type cross drilling unit
  - Backworking 6-spindle unit



## type B

### CNC SWISS TYPE AUTOMATIC LATHE

- Machine composition :
- Main spindle
  - Sub spindle
  - Gang type Tool post
    - Cartridge-type 5-spindle cross drilling unit
    - Cartridge-type 6-spindle cross drilling unit
    - 6-spindle type cross drilling unit
  - Backworking 8-spindle unit with Y-axis control

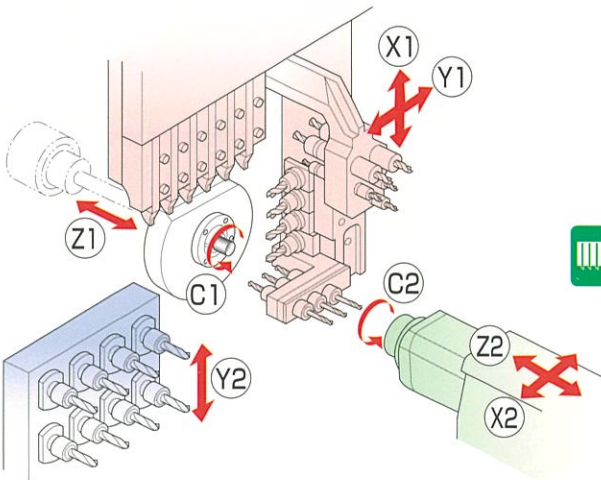

Illustration of tool layout : type B

### TOOLING SYSTEM

■ Tool holder	Turning tool	6 tools
■ 5-spindle sleeve holder	Front-end stationary tool	5 tools
	Rear-end stationary tool	5 tools
■ Power driven tool	Special tool for cross drilling : 3 tools(ER20)+Cartridge type (2pos)	
	4 tools(ER16)+Cartridge type (2pos)	
	6 tools(ER16)	
■ Tool post specially designed for back working unit	typeA	6 tools
	typeB	8 tools(with Y-axis control)

# Accuracy, functionality and productivity upgraded from

## Achievement in High Rigidity and High Accuracy

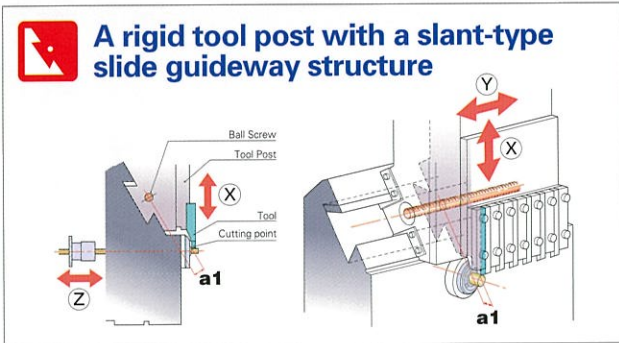

The Y axis guideway of the tool post employs a slant-type slide guideway. This structure allows the X and Y axis guideways to be arranged radially around the cutting point in order to further improve machine rigidity. In addition, a linear line passing the ball screw center and in parallel with the Y axis guideway can be close (a 1) to the cutting point and therefore further increases rigidity and helps improve both accuracy and surface finish on your mill/turn components.

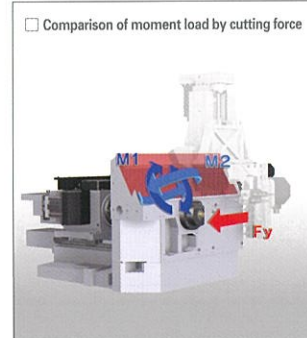

The moment load applied to the guideway surface by cutting force is the combined radial and axial load  $M_y$ . The  $M_y$  of the slant type is the smallest when compared to that of the vertical type and horizontal type.

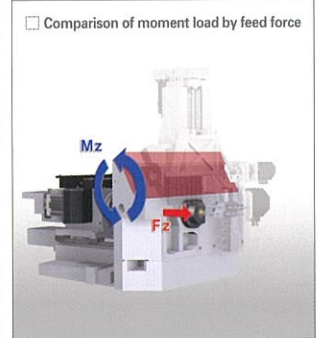
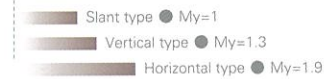

As for the feed force  $F_z$ , the moment load  $M_z$  of the slant type is the smallest when compared to that of the vertical type and horizontal type.

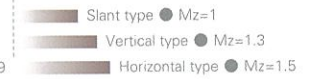

### A highly rigid spindle sleeve structure when using N.G.B. mode

The N.G.B type introduces a spindle sleeve slide guideway structure. By supporting the cutting force on the guideway, the headstock rigidity is maximized and therefore spindle deflection is minimized to ensure machining accuracy is maintained.

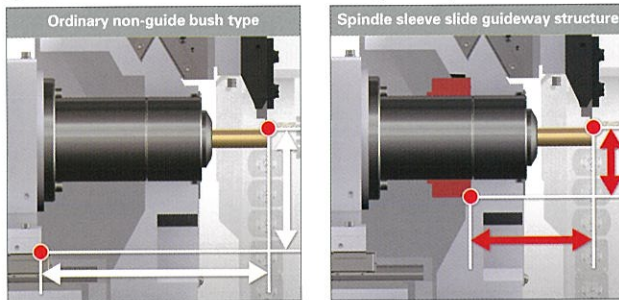

### A built-in spindle for high indexing accuracy

The main and sub spindle employ a built-in structure to enhance spindle indexing speed and accuracy with a built-in sensor.

### Work holding pressure increased by hydraulic cylinder

The hydraulic cylinder helps to improve the workpiece gripping force and allows high machining accuracy by reducing workpiece deflection even under extreme load.

### A high rigid tool post specially designed for back working

A dovetail structure is incorporated in the Y2 slideway on the type B back working tool post. Type A also improves tool post rigidity by increasing the casting thickness.

### Stronger casting implemented

The base casting thickness is increased by 25% compared to the previous model SR-32J. This improves the frame rigidity and demonstrates remarkable effect on suppression of vibration during machining and thermal displacement during continuous operation.

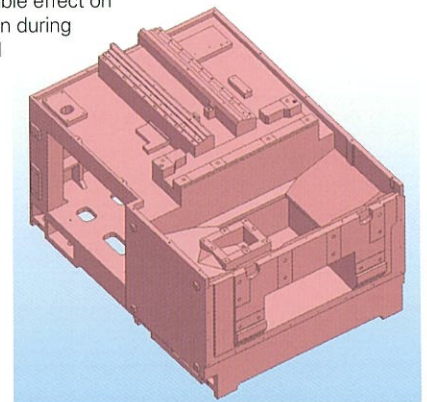

## Pursuit of High Productivity

### Machining time reduction (mechanical)

Front-end/rear-end overlap machining is optimized and cutting time is minimized by numerous back working variations.

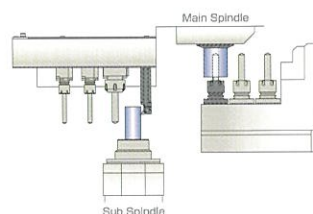

### Machining time reduction (control system)

With a smart overlap function, a path between NC command blocks is overlapped to reduce non-cutting time

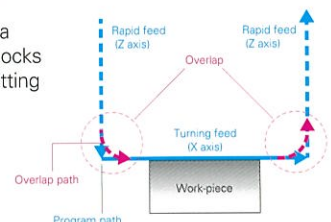

# every angle

## Improvement in High Functionality and Machining Ability



### The G.B. / N.G.B. switching mechanism

The guide bush type and non-guide bush type are switched over according to the total length of machining parts to realize most suitable machining.



### Back working tool post for a broader range of complex machining



A back working tool post is mounted, which can accommodate a maximum of 8 static and/or power tools (type B) with Y axis control and a maximum of 6 static and/or power tools \*1 (type A). Various power tools for slotting, milling, etc. are available to meet versatile complex machining on the rear side.

\*1 : When selecting the power tool drive unit B (optional).



### Selectable cross drilling unit

The cross drilling unit includes three types; 5-spindle type (ER20 x 3 tools + 2-pos. cartridge), 6-spindle type (ER16 x 4 tools. + 2-pos. cartridge) and 6 spindle type (ER16 x 6 pcs.).

### Enlarged tool-to-tool pitch of the back working tool post

The back working tool post has an increased pitch between two tools for OD turning so that large-diameter (max.  $\phi 32$ mm) turning is possible without restriction of neighboring tools. Details on page 7 and 8.

Details in page 7 and 8

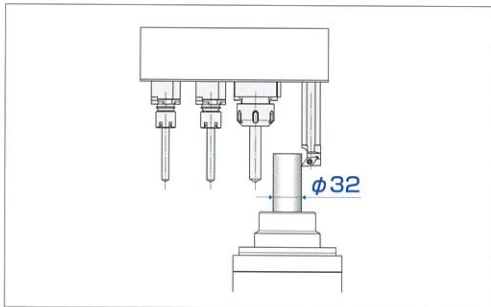

Details in page 5 and 6

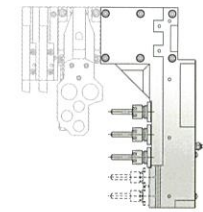

□ 5-spindle type cross drilling unit  
3 tools(ER20)+Cartridge type (2pos)

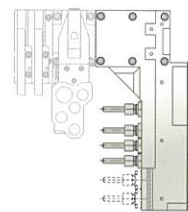

□ 6-spindle type cross drilling unit  
4 tools(ER16)+Cartridge type (2pos)

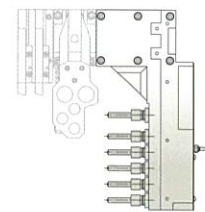

□ 6-spindle type cross drilling unit  
6 tools(ER16)

## Improvement in Operability and Workability

### The movable operation panel

A movable operation panel with 10.4-inch color display is mounted. It allows machine operation from the best position.

### A flip-up door

Both the headstock chamber and the cutting chamber use a large-opening, flip-up door to give the user plenty of room to work.



### The guide bush switching mechanism (G.B./N.G.B.)

The new switching mechanism (G.B./N.G.B.) employs locate blocks so that the switchover is easier and highly reproducible.

### Discharge of machining parts during operation stop

The ON/OFF switch is mounted outside the product conveyor. Machining parts can be manually discharged even while the machine is stopped.

### Structural change in the back working tool post

The lower part of the tool mounting surface is set vertically to expand the chip discharge space.

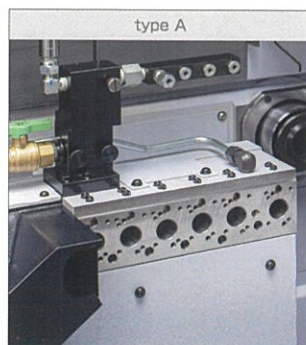
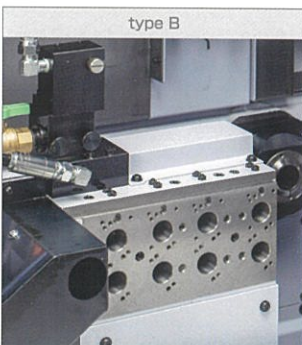

### Increased coolant discharge rate for back working tool post

The motor output of the coolant pump for the back working tool post has been increased from 250W to 400W. This helps to reduce problems caused by chips.

### Enhanced support software for various operations and tasks

- 1 The "counter screen function" is improved to display the number of required components, remaining machining time and machining finish time for the pre-set number of parts.
- 2 A maintenance timer is increased and a maintenance counter is added to display a message when the counter finishes counting.
- 3 A step to follow next blinks on the operation display for switching between the G.B type and N.G.B type to enable speed of changeover.

Two types of models, A and B,  
so the User can choose the optimum functions to meet their

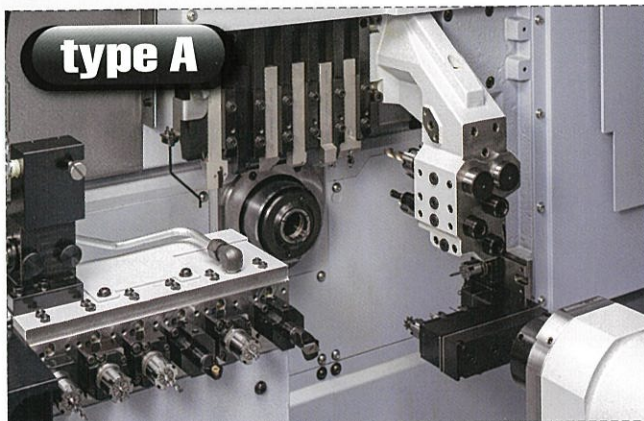

**02**

Gang type Tool post  
**Cartridge-type 6-spindle cross drilling unit**  
ER16x4 tools, Cartridge type 2Pos

Tool post specially designed for back working unit  
**Backworking 6-spindle unit**  
Power-driven tool : Max. 6 tools  
(OP : Drive unit for power-driven attachment B)

**01**

Gang type Tool post  
**Cartridge-type 5-spindle cross drilling unit**  
ER20x3 tools, Cartridge type 2Pos

Tool post specially designed for back working unit  
**Backworking 6-spindle unit**  
Power-driven tool : Max. 6 tools  
(OP : Drive unit for power-driven attachment B)

**03**

Gang type Tool post  
**6-spindle type cross drilling unit**  
ER16x6 tools

Tool post specially designed for back working unit  
**Backworking 6-spindle unit**  
Power-driven tool : Max. 6 tools  
(OP : Drive unit for power-driven attachment B)

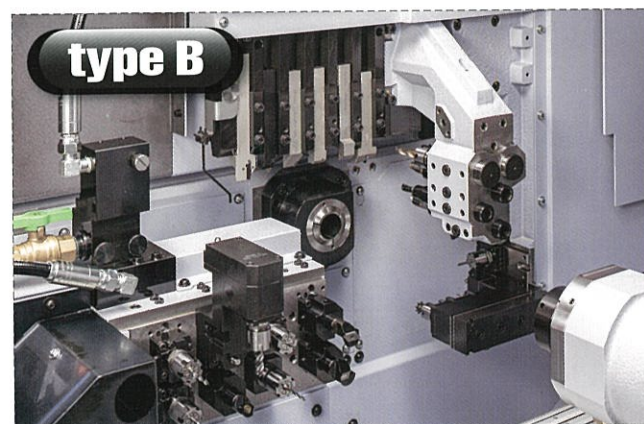

**05**

Gang type Tool post  
**Cartridge-type 6-spindle cross drilling unit**  
ER16x4 tools, Cartridge type 2Pos

Tool post specially designed for back working unit with Y-axis control  
**Backworking 8-spindle unit**  
Power-driven tool : Max. 8 tools

**04**

Gang type Tool post  
**Cartridge-type 5-spindle cross drilling unit**  
ER20x3 tools, Cartridge type 2Pos

Tool post specially designed for back working unit with Y-axis control  
**Backworking 8-spindle unit**  
Power-driven tool : Max. 8 tools

**06**

Gang type Tool post  
**6-spindle type cross drilling unit**  
ER16x6 tools









Tool post specially designed for back working unit with Y-axis control  
**Backworking 8-spindle unit**  
Power-driven tool : Max. 8 tools

# requirements

**type A**  
**type B**

## TOOLING SYSTEM Cartridge-type cross drilling unit – 5-spindle / 6-spindle

Station for mounting tools for more evolved complex machining. The 2 cartridge stations accommodate tools for milling, front drilling, thread whirling, slotting, polygon machining, etc. These positions further increase the flexibility of the machine.

-  Tool
-  Cross drilling only
-  Sleeve holder
-  Milling unit
-  3-spindle front drill unit
-  Quad-speed milling unit
-  2-spindle front drilling adaptor
-  Special unit

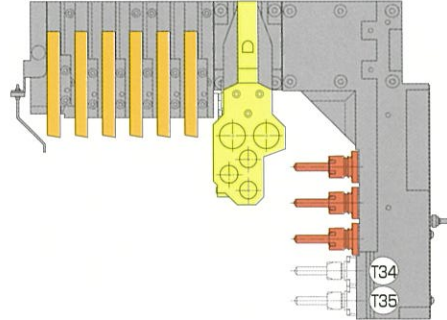

### Basic type

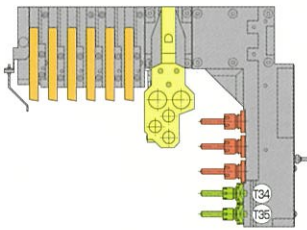

※ The 5-spindle type is shown.



**VARIATION 01**  
Cartridge (2 pos.)

-  Milling unit [T34 / T35]
- or
-  Quad-speed milling unit [T34 / T35]

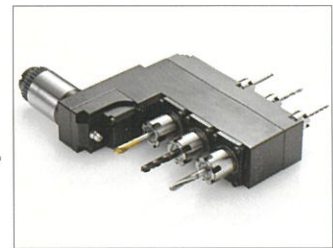
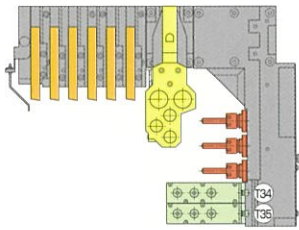

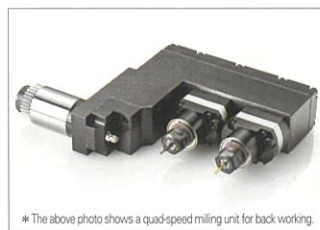
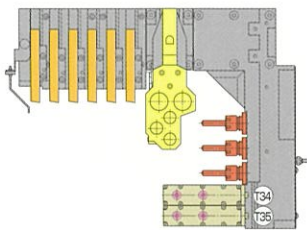

**VARIATION 02**  
Cartridge (2 pos.)

-  3-spindle front drilling unit [T34 / T35]



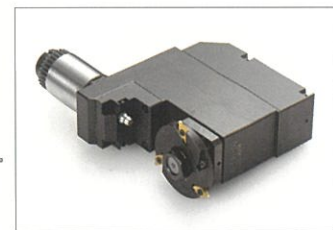
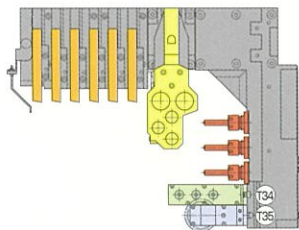

**VARIATION 03**  
Cartridge (2 pos.)

-  2-spindle front drilling adaptor×2 [T34, T35]
-  Quad-speed milling unit for back working×4



**VARIATION 04**  
Cartridge (2 pos.)

-  3-spindle front drilling unit [T34]
-  Polygon machining unit [T35]

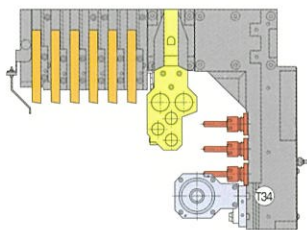

**VARIATION 05**  
Cartridge (1 pos.)

-  Thread whirling unit [T34]

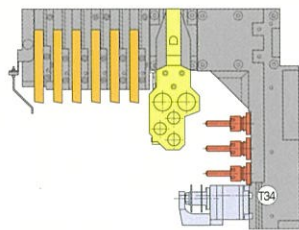

**VARIATION 06**  
Cartridge (1 pos.)

-  Slotting unit [T34]

TOOLING SYSTEM 6-spindle back working unit

type A

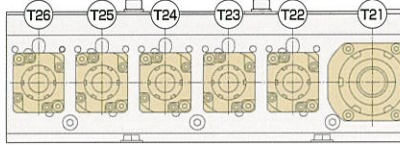
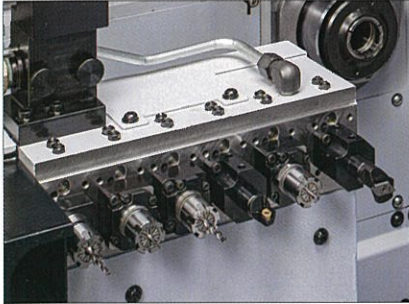

- Max. 6 power tools accommodated
- Various power tool units available
- Coolant-through tool compliant

case01

Mounting of slotting unit

- Mounting is possible onto T21/T22/T24/T26 positions.

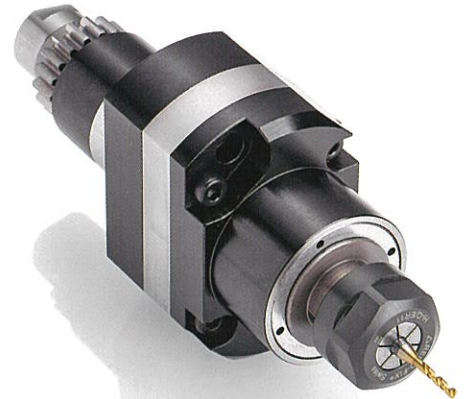
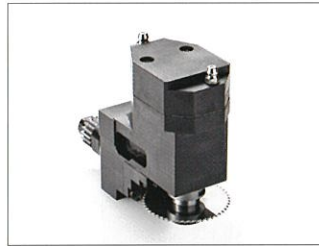
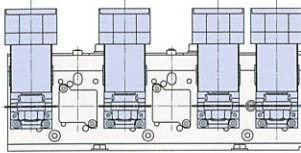

\* The above photo shows a quad-speed milling unit for back working.

07

Coolant-through type compliant

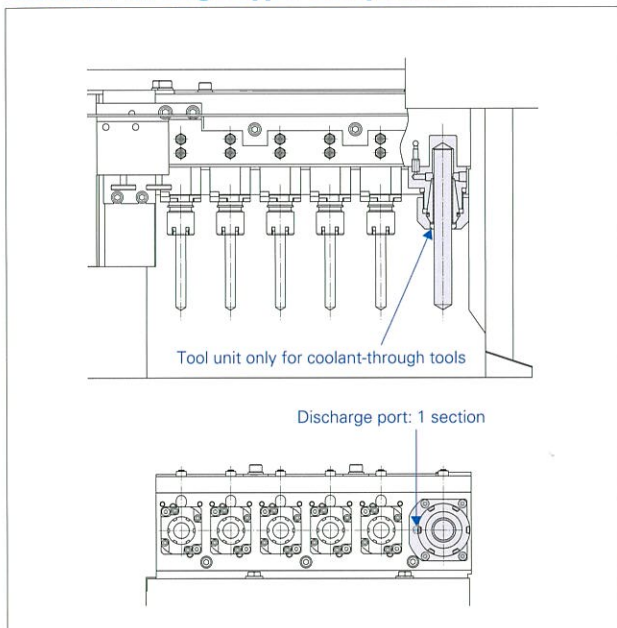
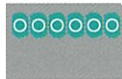

Tool-to-tool pitch

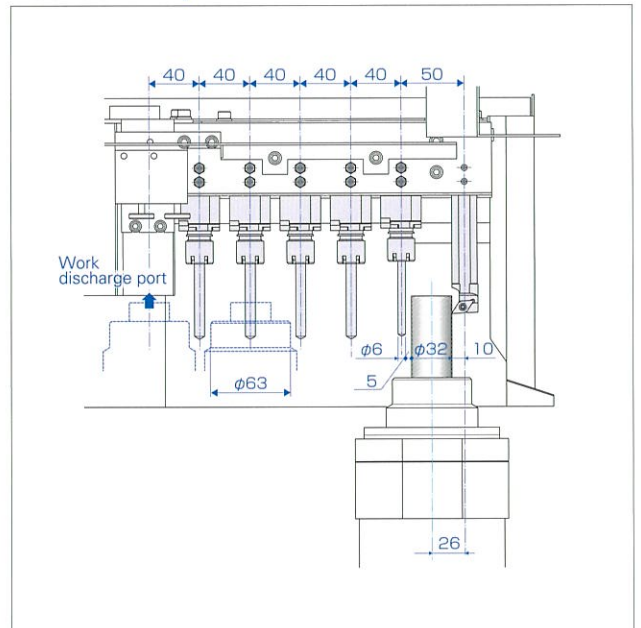
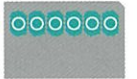



TOOLING SYSTEM Backworking 8-spindle unit with Y-axis control

**type B**

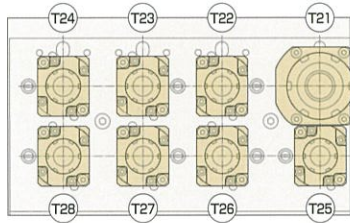
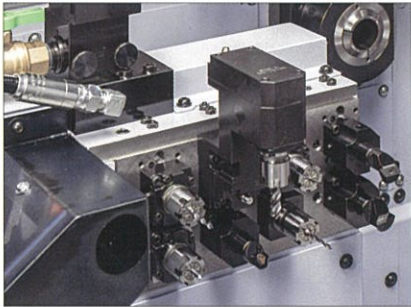

- Max. 8 power tools accommodated
- Various power tool units available
- Coolant-through tool compliant

case01

**Mounting of cross drilling unit**

- Mounting is possible onto T21-24 positions.
- Continuous mounting to neighboring positions

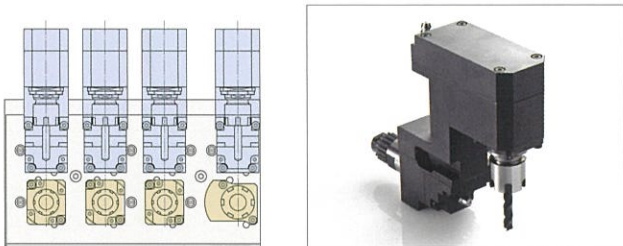

case02

**Mounting of slotting unit**

- Mounting is possible onto T21-24 positions.
- Continuous mounting to neighboring positions

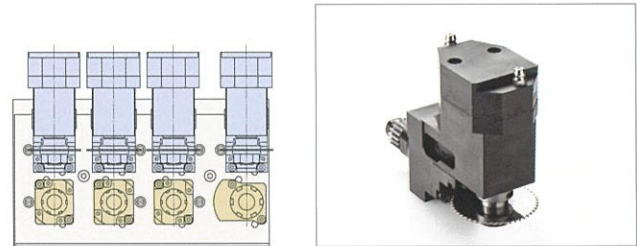

08

**Coolant-through type compliant**

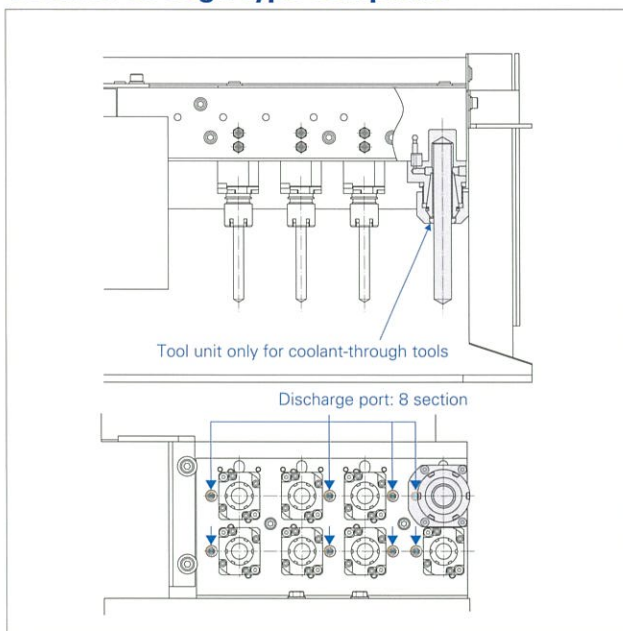

**Tool-to-tool pitch**

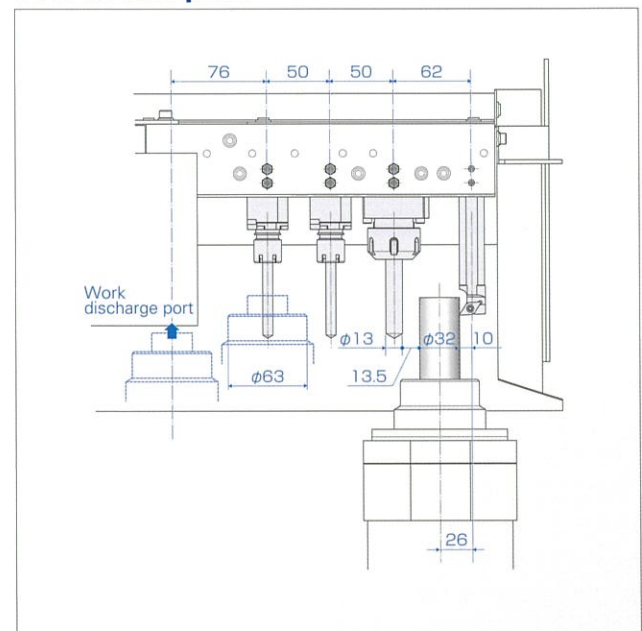

# Machining variations for wider needs

## Front working variation

### VARIATION 01

Machining by front working drilling unit

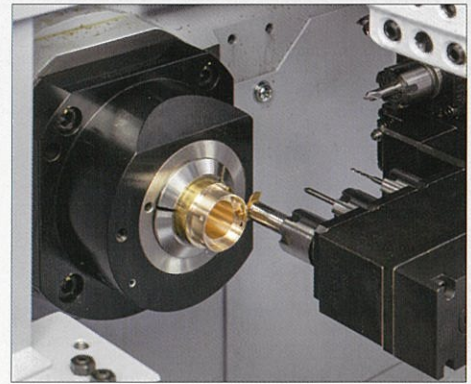
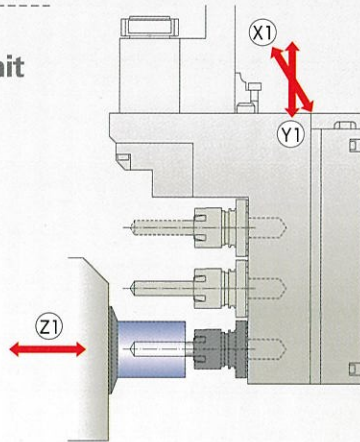

Slitting by T-slot cutter

### VARIATION 02

Machining with cross drilling unit

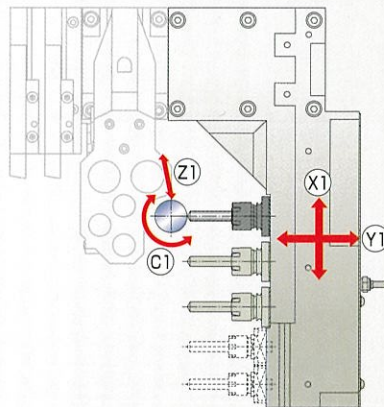

Cross hole ID chamfering

### VARIATION 03

Front hole drilling

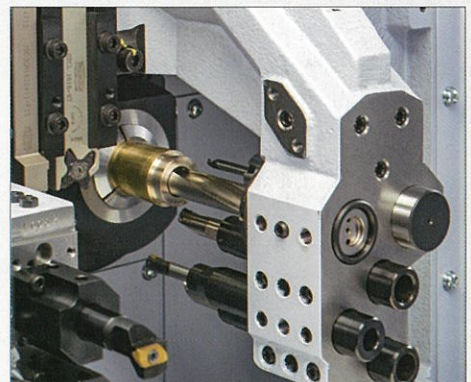
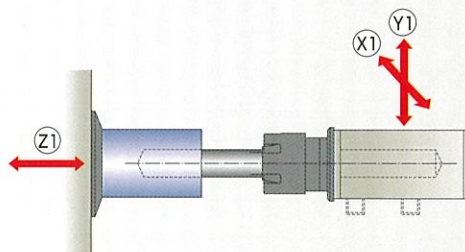

Large-diameter hole drilling

Back working variations

VARIATION 01

Rear eccentric drilling

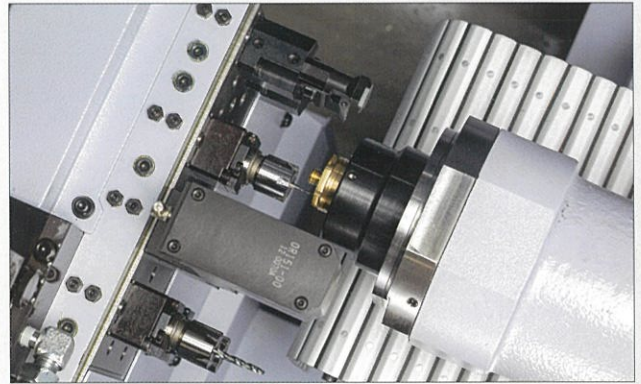
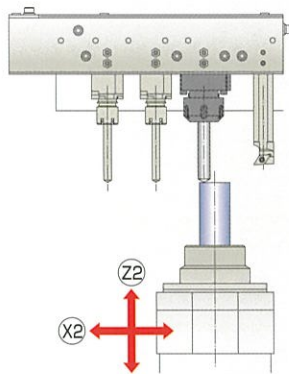

VARIATION 02

Rear cross milling \* type B

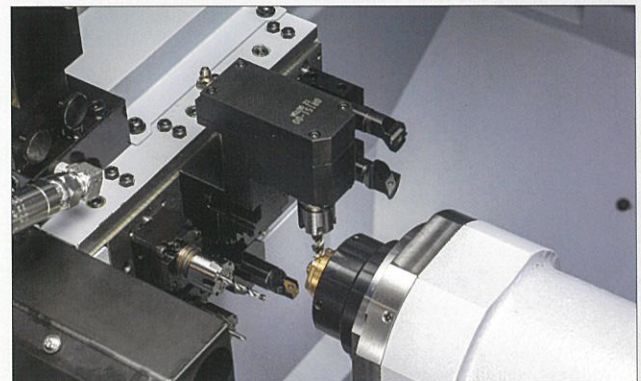
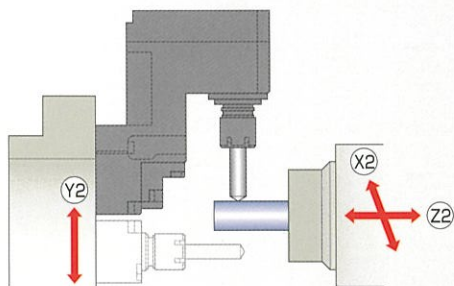

10

VARIATION 03

Rear OD machining

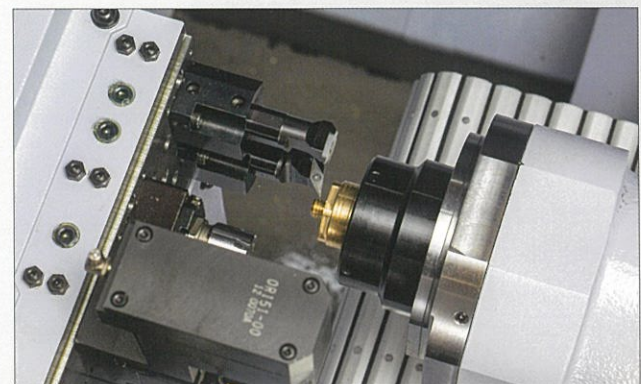
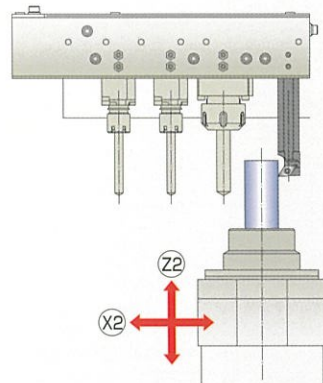

## Standard Machine Specifications

Item	Specifications	
Max. machining diameter	φ32mm(1-1/4in) OP: φ34mm(1-11/32in)	
Max. headstock stroke	Standard	320mm(12-19/32in)
	R.M.G.B. type	286.5mm(11-9/32in)
	N.G.B. type	Bar diameter×2.5(Max.80mm)(Max.3-5/32in)
Tool	Number of tools	6 tools
	Tool shank	□16mm
5-Spindle sleeve holder	Number of tools	Front 5 tools Rear 5 tools
	Max. drilling capability	φ13mm(33/64in)
	Max. tapping capability	M12×P1.75
Power driven attachment	Number of tools	Cross milling 3 tools(ER20) + Cartridge type 2 positions
		Cross milling 4 tools(ER16) + Cartridge type 2 positions
		Cross milling 6 tools(ER16)
	Max. drilling capability	φ10mm(25/64in)
	Max. tapping capability	M8×P1.25
	Spindle speed	Cross milling : Max.6,000min <sup>-1</sup> Cartridge-type tool : Max.8,000min <sup>-1</sup>
Rapid feed rate	Drive motor	2.2kW(continuous) / 3.0kW(5min./30%ED)
		35m/min ( X1, X2, Y1, Z1, Z2 ), 24m/min ( Y2 ) : type B only
Main spindle indexing angle	C-axis control	
Main spindle speed	Max.8,000min <sup>-1</sup>	
Main spindle motor	7.5kW(continuous) / 11.0kW(10min./25%ED)	
Coolant tank capacity	275 ℓ	
Dimensions (W×D×H)	2,690×1,345×1,780mm	
Weight	4,100kg	
Power consumption	8.1kVA	
A-weighted sound pressure : note-1	Max.77dB	

## Backworking Attachment Specifications

Item	Specifications		
Max. chucking diameter	φ32mm(1-1/4in) OP: φ34mm(1-11/32in)		
Max. length for front ejection	125mm(4-59/64in)		
Max. parts projection length	45mm(1-49/64in)		
Unit especially for backworking note-2	Number of tools	6 tools(type A) 8 tools(type B)	
	Max. drilling capability	Stationary tool	φ13mm(33/64in)
		Power driven tool	φ8mm(5/16in)
Max. tapping capability	Stationary tool	M10×P1.5	
	Power driven tool	M 6×P1.0	
Power-driven att. spindle speed	Max.6,000min <sup>-1</sup>		
Power-driven att. drive motor	1.0kW(continuous) / 1.2kW(5min./30%ED)		
Sub spindle indexing angle	C-axis control		
Sub spindle speed	Max.8,000min <sup>-1</sup>		
Sub spindle motor	3.7kW(continuous) / 5.5kW(10min./40%ED)		

## External Dimensions and Floor Space

unit : mm(ft)

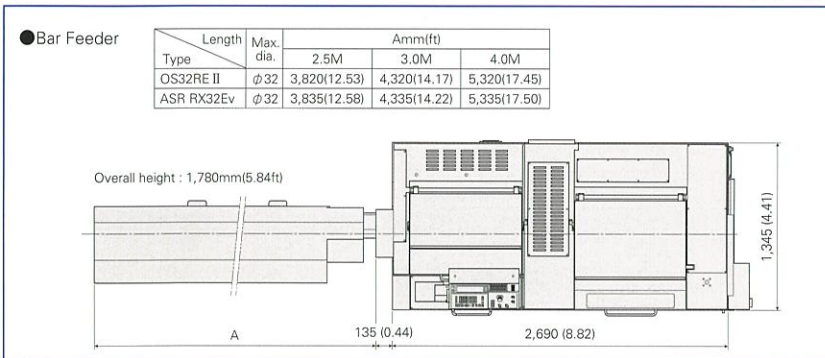

※Design features, specifications and technical execution are subject to change without prior notice.

※This product is an export control item subject to the foreign exchange and foreign trade laws. Thus, before exporting this product, or taking it overseas, contact your STAR MICRONICS dealer.

## Standard Accessories and Functions

- CNC unit FANUC 32i-B
- Operation panel 10.4-inch color LCD display
- Manual pulse generator
- Pneumatic unit
- Hydraulic unit
- Coolant level detector
- Automatic centralized lubrication unit
- Door interlock system
- Cs contouring control (Main / Sub)
- Spindle clamp unit (Main / Sub)
- Spindle cooling unit
- Revolving guide bush unit
- Drive unit for revolving guide bush
- Air purge for revolving guide bush
- Main / Sub collet
- 6-station tool holder □16mm
- Cross drilling unit (Cartridge type – 5-spindle / 6-spindle, special tool for cross drilling unit – 6-spindle)
- 5-spindle sleeve holder
- Broken cutoff tool detector
- Backworking attachment
- Back 6-spindle unit ※type A
- 8-spindle backworking unit with Y axis control function ※type B
- Drive unit for power-driven (8-spindle backworking unit) ※type B
- Sub spindle air purge unit
- Parts conveyor
- Work light
- Leakage break

## Optional Accessories and Functions

- Coolant flow detector
- Water removal unit
- Oil mist filter
- Beacon
- Main spindle inner tube
- Rotary magic guide bush unit
- Non-guide bush type
- Feed arrow steady rest ※type A Only
- Drive unit for power-driven attachment B
- Parts ejector (Spring type)
- Parts ejector (Air cylinder type)
- Parts ejector with guide tube
- Parts stopper unit
- Coolant unit (6.9MPa/2.5MPa/0.7MPa)
- Coolant unit signal cable
- Coolant unit power cable
- Coolant valve
- Coolant pipings
- Automatic bar feeder interface
- LAN/RS232C interface
- Transformer
- Transformer CE marking version
- Transformer CE marking specifications

Note)

The machining capacities apply to SUS303 material. The machining capacities may differ from listed values depending on the machining conditions, such as the material to be machined or the tools to be used.

note-1 : ● Measures conforming to ISO standard.

● A-weighted sound pressure is a general assessment standard characteristic that corrected the sound level to human acoustic sense.

note-2 : ● In order to use the rotary tool, the driven system for power-driven tool type B is needed.(TypeA)

# STAR MICRONICS CO., LTD.

## Machine Tools Division

1500-34 Kitanoya, Misawa, Kikugawa, Shizuoka, 439-0023 Japan  
TEL.+81-537-36-5594 FAX.+81-537-36-5607

<http://www.star-m.jp/eng/>

### Star CNC Machine Tool Corporation

123 Powerhouse Road, Roslyn Heights, NY11577, U.S.A.  
TEL.+1-516-484-0500 FAX.+1-516-484-5820

### Star Micronics GB Limited

Unit 1 Riverlands Business Park Raynesway DERBY DE21 7EZ  
TEL.+44-1332-86-44-55 FAX.+44-1332-86-40-05

### Star Micronics GmbH

Robert-Grob-Str.1, D-75305 Neuenburg, Germany  
TEL.+49-7082-7920-0 FAX.+49-7082-7920-20

### Star Micronics AG

Lauletstrasse3, CH-6112 Otelfingen, Switzerland  
TEL.+41-43-411-60-80 FAX.+41-43-411-60-66

### Star Machine Tool France

90 Allee de Glaisy, ZI, 74300 Thyez Haute Savoie, France  
TEL.+33-450-96-05-97 FAX.+33-450-96-91-54

### Shanghai Xingang Machinery Co., Ltd.

2F, 229 Fute Rd.N. The China (Shanghai) Pilot Free Trade Zone  
TEL.+86-21-5868-2100 FAX.+86-21-5868-2101

### Star Micronics (Thailand) Co., Ltd.

289/23 M.13 Soi Kingkaew 25/1, Kingkaew Rd., T.Rachathewa A.Bangplee Samutprakarn 10540, Thailand  
TEL.+66-2-186-8945-47 FAX.+66-2-183-7845

**9001 ISO 14001**  
CERTIFIED

2021.05\_Ver1.0\_1